

ELECTRONIC LOCKSET

OPERATION AND MAINTENANCE MANUAL



SAFEHINGE PRIMERA[®]
LIFESAVING DETAILS

Use of Operation and Maintenance Guidelines

These guidelines are to aid the operation and maintenance of products supplied by Safehinge Group Limited. It is essential that the guidelines are followed to ensure the products function correctly and do not jeopardise the safety of staff or service users.

The operation manual provides a general overview of product use, more detail can be found in product specific documents.

The maintenance manual outlines procedures to ensure products are maintained correctly and that the product continues to function safely. The level of maintenance will depend on the frequency of use and severity of the environment the product is installed within. The onus is on the building owner/employer/occupier to ensure that the maintenance routine is carried out by suitably qualified and competent individuals.

Copyright and Patent

No part of this publication may be reproduced or edited in any form or by any means whether electronic, mechanical, photocopying, recording, or otherwise, without Safehinge Group Limited's prior written permission. This document and all other documentation supplied by or on behalf of Safehinge Group Limited are also copyright Safehinge Group Limited – all rights are reserved.

The Safehinge Group Limited's Electronic Access Control Hardware is protected by intellectual property rights and is patent protected.

Safehinge Primera (SHP) is a brand of Safehinge Group Limited and will be referred to throughout this document.

Disclaimer

Other than death or personal injury caused by negligence and other liabilities which may not be excluded or limited by law, Safehinge Group Limited excludes any and all liability for (a) failure to follow the guidelines or other technical documentation in any manner; and/or (b) defective or inaccurate installation and/or maintenance of the doorset and/or any of its components.

Copyright © 2023
Safehinge Group Limited

CONTENTS

Operation Manual	4
Credentials	4
Standard Use Light Sequence.....	5
Override Procedure.....	7
Maintenance Manual	8
Maintenance Schedule	9
Override.....	10
Lubrication	10
Battery Replacement.....	10
Troubleshooting	12
Pairing.....	14
Safety Information	15
Compliance	16
Support	17
Manufacturer's Warranty.....	17

OPERATION MANUAL

CREDENTIALS

The Electronic Lockset is compatible with the following Mifare Credentials:

- Ultralight
- Classic 1K
- Classic 4K
- DESFire EV1 & EV2

SHP can provide the following Classic 1K credentials.

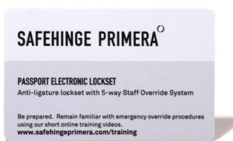

Smart Card

Part No. : PR-6904-UCP

Technology: Mifare Classic 1K



Tear Fob (Black)

Part No. : PR-6914-EGF

Technology: Mifare Classic 1K



Adjustable Wristband

Part No. : PR-6934-AWB

Technology: Mifare Classic 1K

The adjustable wristband has a 4.8kg break force and is recommended for service users.

USING CREDENTIALS

To use the credentials, hold them to the contact area of the lockset until access has been granted or denied (green or red). Aim for the centre of the contact area to ensure reliable reading.

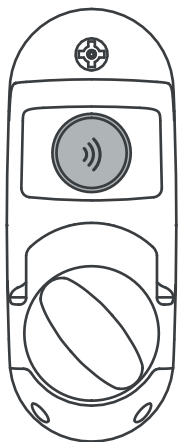

Electronic Lockset

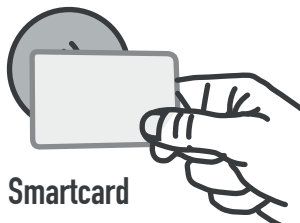

Smartcard

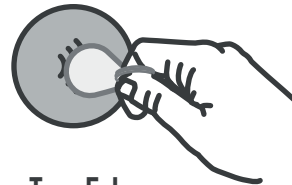

Tear Fob

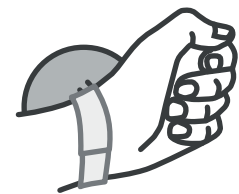

Wristband

STANDARD USE LIGHT SEQUENCE

Once the credential has been correctly presented to the contact area, indicated by a **solid white light for 0.5 seconds**, a series of light sequences will be displayed. The diagram below shows the possible responses from the Electronic Lockset during standard use.

Credential Feedback

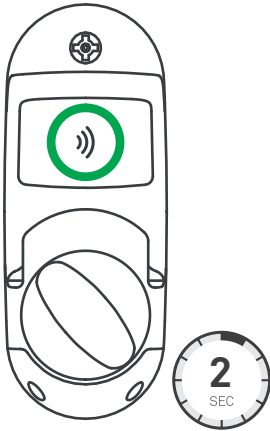

Green - Access Granted
A solid green light for 2 seconds indicates that the credential has been granted access to the room

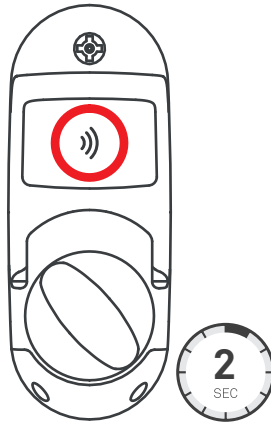

Red - Access Denied
A solid red light for 2 seconds indicates that the credential has been denied access to the room

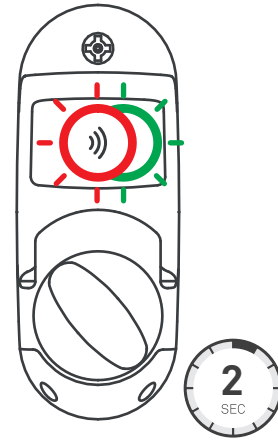

Red/Green - Invalid Credential
A flashing red and green light for 2 seconds indicates that the credential type is not recognised

Battery Status

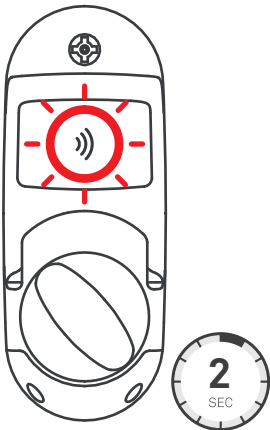

Red - Battery Low
A flashing red light for 2 seconds indicates that the battery level is low (<30%)

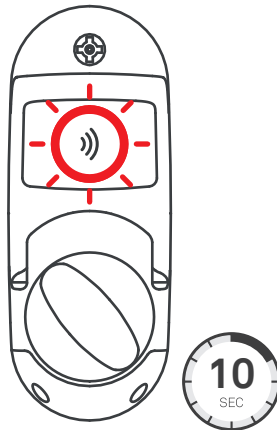

Red - Battery Critical
A flashing red light for 10 seconds indicates that the battery level is critical (<15%)

Battery Status
The battery status warnings will show after the credential feedback has been displayed

PRODUCT DIAGRAM

Electronic Lockset

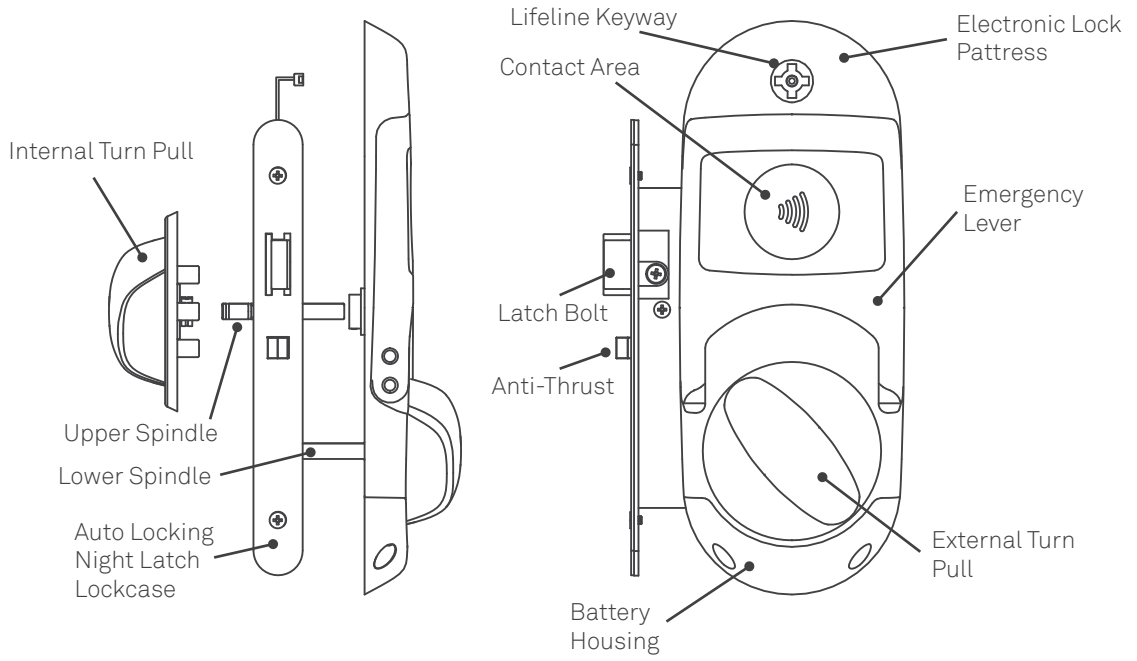

Hub

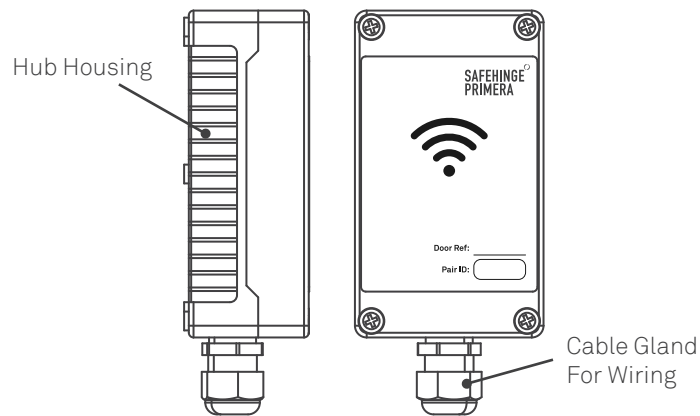

Oryx Lever Handle

Suitable for low risk or dementia wards only.

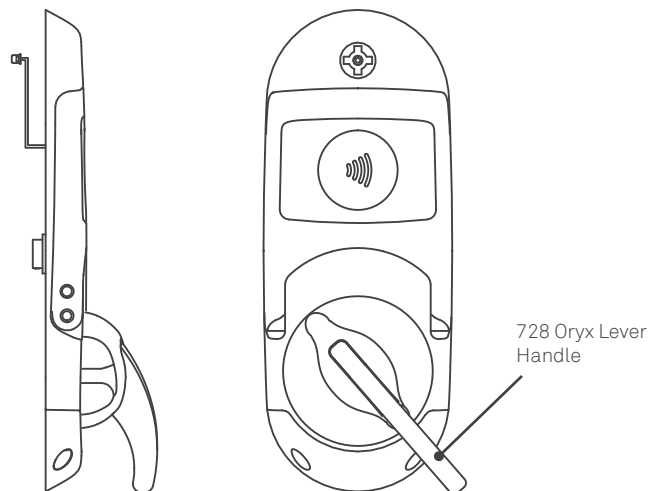

OVERRIDE PROCEDURE

The Electronic Lockset has an integrated override system allowing entrance into the room against even the most determined barricades. Training should be provided to all staff members on how to use the override feature. The override feature is only to be used in anti-barricade situations, or in the rare event of electronic failure.

1

Before activating the emergency override, ensure the outward opening swing of the door is clear.

If the door has an anti-barricade stop, this must also be removed before activating.

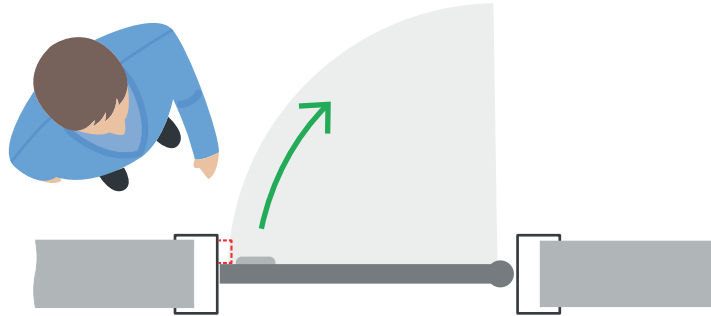

Remove anti-barricade stop

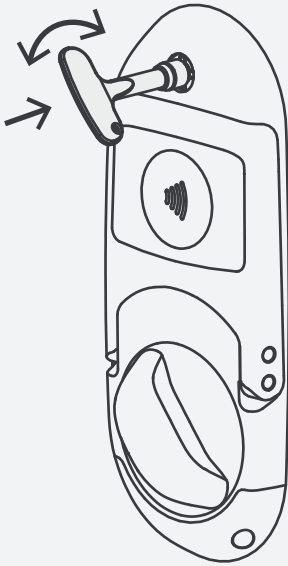

2

Using your staff-only Lifeline key, activate the emergency lever. The key can be rotated 15 degrees clockwise or anticlockwise.

If the handle does not automatically deploy check for any obstructions. Manually pull down the handle - but only whilst using the Lifeline key.

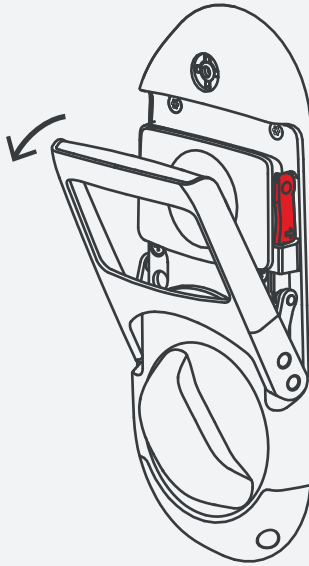

3

Once the handle has been released, push it down to a horizontal position to unlock the door.

A ratchet mechanism locks the lever in position, deactivating the internal turn pull.

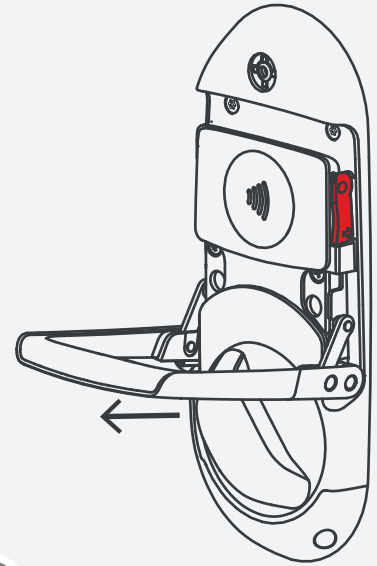

4

Use the emergency lever to pull the door open.

5

To reset the emergency lever, first press down the two red switches. The lever is then free to be pushed back to its stored position.

Ensure the handle is fully secured in place before vacating the area.

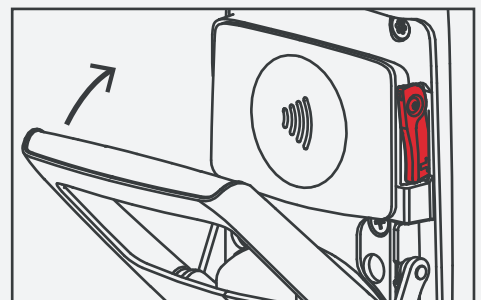
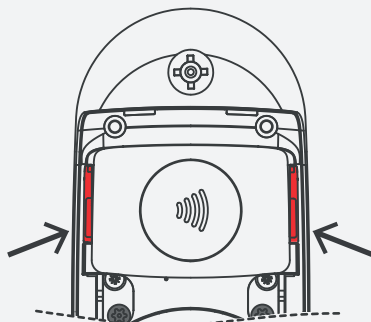







MAINTENANCE MANUAL

The maintenance of SHP products is essential to proper function and safety and must be completed as specified. Any maintenance work must be carried out by suitably qualified and competent individuals.

If any installed SHP product is removed/changed at any time it may impact the performance of the system. It must be recommissioned and tested by an approved technician.

TYPES OF MAINTENANCE

It is important that all products are installed correctly as per the instructions to ensure safe and effective performance. To maintain this level of performance our products require a range of different checks to ensure they continue to meet the highest safety standards.

Visual Inspection		Visual checks on the product and surrounding door/frame/environment looking for wear, damage and general condition
Mechanical Checks		Consists of checking that the product's mechanical elements function properly without any binding or undue force required. Check that parts can move freely without abnormal resistance or binding
Electronic Checks		General tests on the electronics to check products are connected and communicating correctly with relevant systems and battery levels are acceptable
Fixings Check		Fixings need to be checked regularly and tightened when necessary to ensure products do not become loose and provide potential ligature/weaponisation risks. This also checks that no projection of fixings prevent components from moving freely
Cleaning		Build up of grease, dust and harmful chemicals (e.g from floor cleaning) should be removed to prevent corrosion and maintain the product finish and function. The correct cleaning method should be used to ensure products are not damaged
Lubrication		Some products will benefit from periodic lubrication RS High Specification Dry Lubricant only (RS part number 251-3794) B700241. Note: We cannot endorse the use of any other lubricants

MAINTENANCE SCHEDULE

It is essential that the customer implements a regular maintenance regime to support the correct function of all our products. **The frequency of checks recommended is a guideline and should be commensurate with frequency of use/severity of the environment in which it is installed.**

The following section outlines checks that should be carried out on the Electronic Lockset. **If any product fails any of these tests, please contact your maintenance provider.**

	Product	Maint. Type	Maintenance
Weekly These items should be checked weekly and adjustments made where necessary.	Electronic Lockset		Visual Inspection - A visual inspection of the product and the surrounding environment to check there is no signs of damage. Check that all hardware is flush to the wall with no ligature risks.
	Electronic Lockset		Cleaning - All parts should be cleaned with mild detergent only with a damp cloth. Avoid contacting these components with aggressive cleaning fluids or excessive fluids of any kind.
Monthly In addition to the weekly schedule, these items should be checked on a monthly basis and adjustments made where necessary.	Electronic Lockset		Override Test - Complete a full cycle of the override system to check it is functioning correctly
Quarterly In addition to the weekly and monthly schedule, these items should be checked on a quarterly basis and adjustments made where necessary.	Electronic Lockset		Fixing Checks - Ensure the fixings are holding the product securely in place.
	Night latch lockcase		Lubrication - Regular lubrication is essential for lock function. See the following section of this document for the application of lubricant.
Annually In addition to the weekly, monthly and quarterly schedule, these items should be checked on an annual basis and adjustments made where necessary.	Electronic Lockset		Battery Replacement - The batteries are recommended to be changed annually. The Electronic Lockset will flash red for 2 seconds when the batteries need replaced.

OVERRIDE

To test the override, follow the complete override instructions within the operation manual. Check the Lifeline keyway has not been tampered with and the emergency lever releases when activated.

LUBRICATION

Moving parts should be regularly lubricated with High Specification Dry Lubricant only.

To lubricate Safehinge Primera Night latch lockcases, push the latch in and spray into the lockcase then repeat this with the anti-thrust.

Safehinge Primera products are supplied with anti-tamper security screws. These must not be substituted with any other fixings. Any missing screws should be replaced with identical anti-tamper fixings.

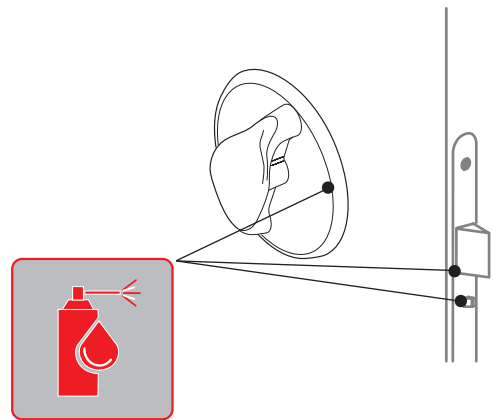

BATTERY REPLACEMENT

TX25 security driver required

Note: the screws are captive and will not come loose from the tray.

1

Undo the two fixings at the bottom of the pattress and slide the tray downwards.

Part No: PR-7268-V3

Note: take care when disconnecting the battery not to damage the cables.

2

Remove the battery pack and disconnect the cable. Discard of the old battery pack responsibly.

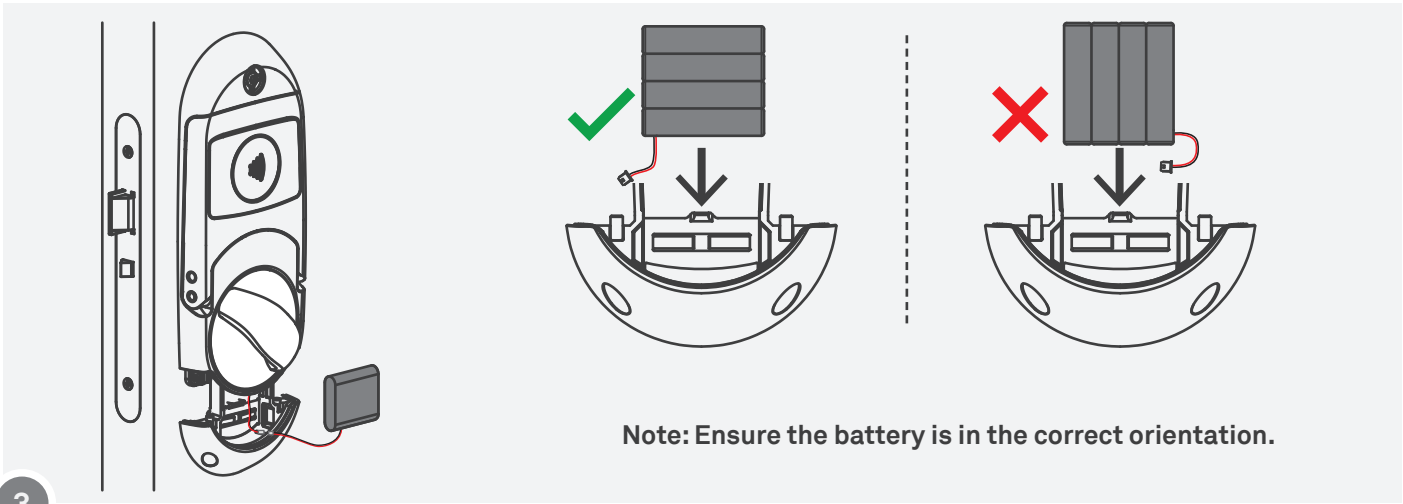

Note: Ensure the battery is in the correct orientation.

3 Connect the new battery pack. Rotate the batteries to the correct orientation (as shown above).

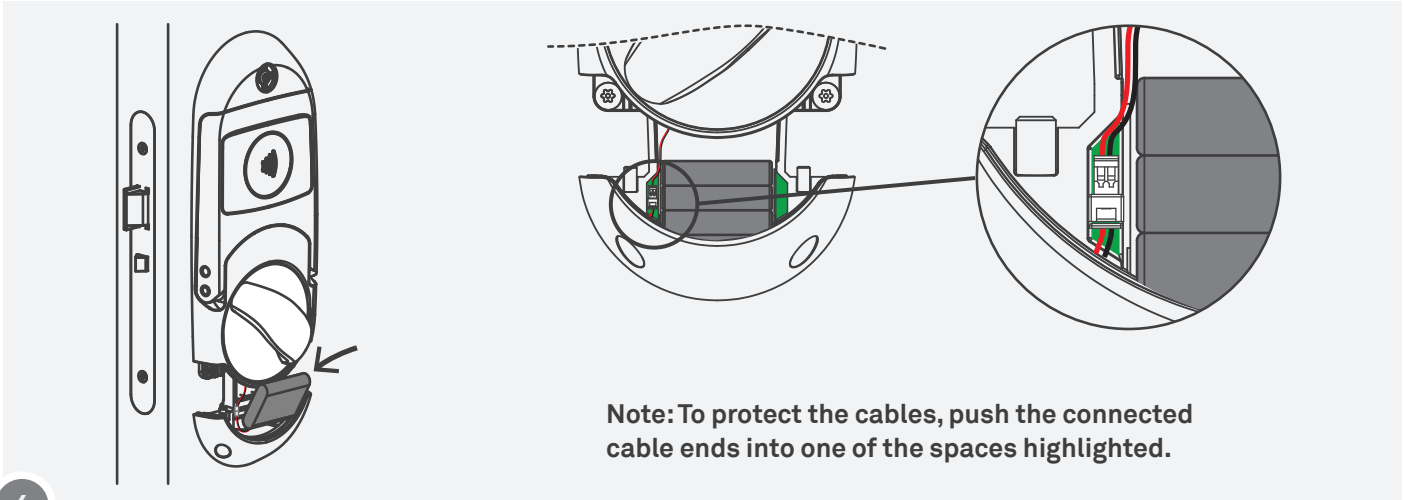

Note: To protect the cables, push the connected cable ends into one of the spaces highlighted.

4 Angle the battery pack into the battery tray.

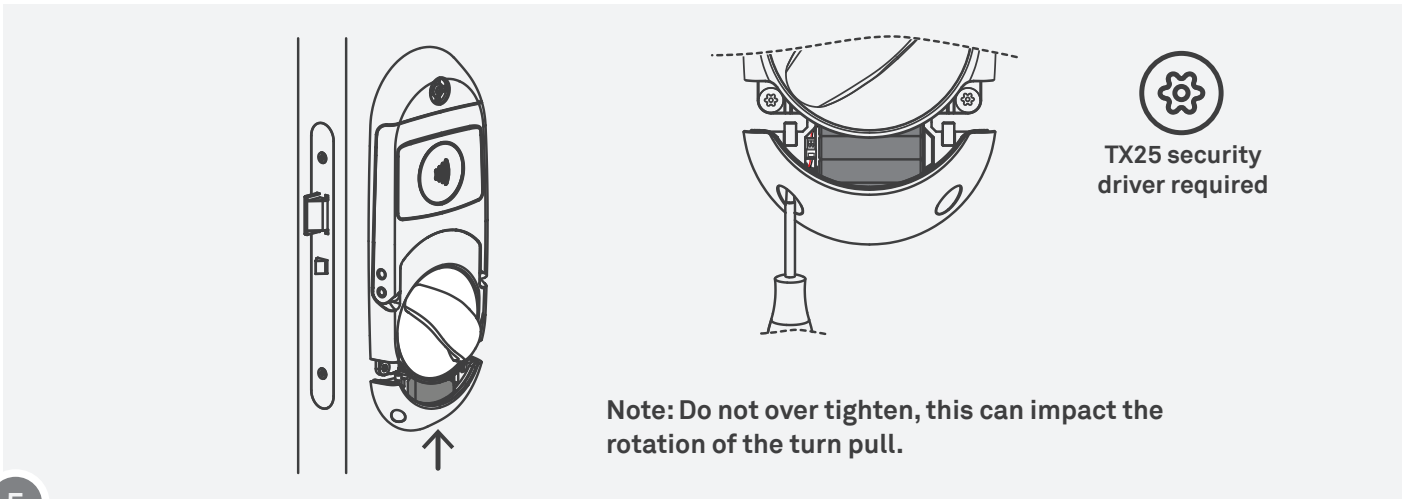











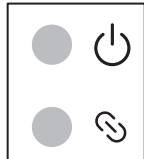

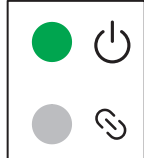
Note: Do not over tighten, this can impact the rotation of the turn pull.

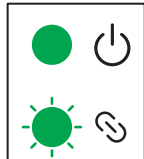

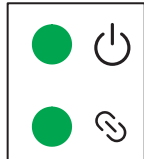

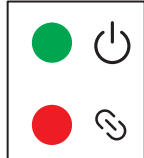

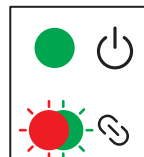

TX25 security driver required

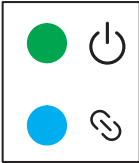
5 Once the battery and cable are in the correct location, slide the battery tray upwards. Using a TX25 security torx screw driver, tighten the two captive fixings.

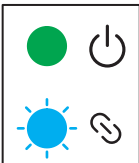
TROUBLESHOOTING

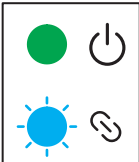
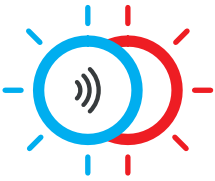
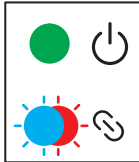
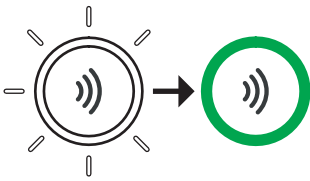
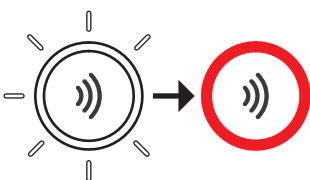
The following troubleshooting guide provides a basic diagnostic of potential issues.

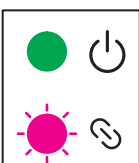
Action	Lock LED Display	Lock LED Behaviour	Hub LED Display	Hub LED Behaviour	Resolution
No response		No response		No response	Ensure Lockset and Hub have power
Power on		Green on 2s		Green on permanently	
Successful boot sequence		Green flash 2s		Green flash 2s	
Card Read		White on 0.5s			
Access Granted		Green on 2s		Green on 2s	
Access Denied (unauthorised credential)		Red on 2s		Red on 2s	Check credential access rights
Access Denied (invalid credential)		Green + red flash 2s		Green + red flash 2s	Use a Mifare family credential
Battery Low		Red flash 2s			Replace battery
Battery Critical		Red flash 10s			Replace battery

Action	Lock LED Display	Lock LED Behaviour	Hub LED Display	Hub LED Behaviour	Resolution
Paired, trying to communicate, no RSSI		Blue on 2s		Blue on 2s	Check Hub is powered on. Move Hub closer to lockset
Low RSSI		Blue flash 2s			Move Hub closer to Lockset
Pairing - Lockset pairing open		Blue flash 10s			
Pairing - Hub pairing open				Blue flash 30s	
Pairing - Identify paired unit		Green flash 2s		Blue flash 5 minutes, or until pair button pressed	
Pairing - Not Paired		Blue + Red flash 2s		Blue + red permanently on	Pair Lockset to Hub
Entered Install Mode		Green flash 2s White on 1s			
Exit Install Mode		White flash 2s Red on 1s			
Hub to Door controller communication error		Purple flash 2s		Purple flash 2s	Check the Hub to door controller connection and check the settings within the access control software.

PAIRING

All Electronic Locksets will come factory paired and this will be shown on the pair ID. In the unlikely event of a product failure, you may need to re-pair to a new Lockset or Hub.



1. The replacement device pair ID will not match the original device. Write the door reference on the replacement device.
2. Power on both devices that need to be paired. The pairing data must be removed from the original device before it can be re-paired. For a replacement Lockset the original Hub needs to be unpaired, for a replacement Hub the original Lockset needs to be unpaired. To unpair the original device, press and hold the pair button on the device for 10s. Once the button is released the lights on the device will flash red and blue to indicate successful unpairing.

Lockset Pair Button

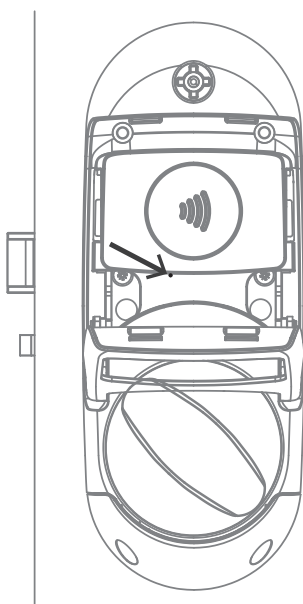

Hub Pair Button

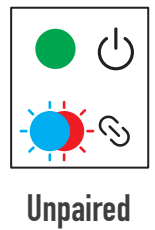
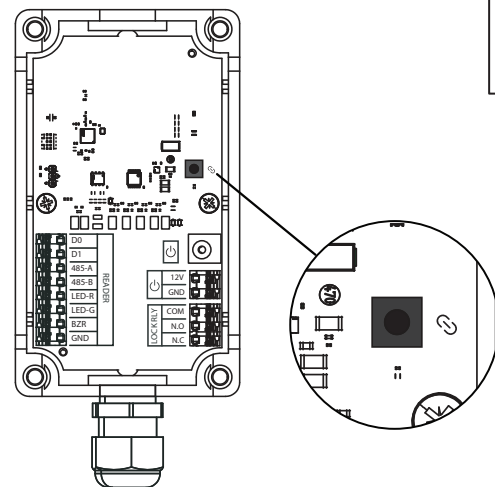

3. Press the pair button on the Hub to open pairing. The red and blue light will change to flash blue. Pairing on the hub will remain open for 30s.

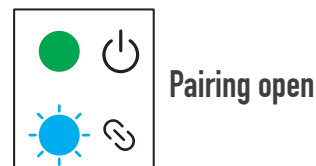

4. Within these 30 seconds press the pair button on the Lockset. It will start to flash blue. If it pairs successfully, the Lockset and Hub will flash green for 2s. If the devices do not pair the Lockset will time out after 10s and flash red and blue for 2s.

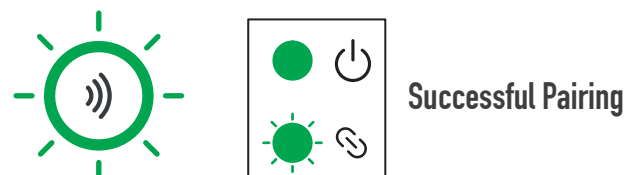

SAFETY INFORMATION

SAFETY NOTICES

1. Read, follow and keeps these instructions
2. Heed all warnings
3. Only use attachments/accessories specified by SHP



Ensure the product has been installed correctly and signed off before use



Do not use this product in a location that can be submerged/come into contact with water

ELECTRICAL SAFETY INFORMATION

- All electrical equipment should be installed, serviced and maintained by an approved technician.
- Compliance is required with respect to the voltage, frequency and current requirements. Connection to a different power source than specified by SHP may result in improper operation, damage to the equipment, or pose a fire hazard.

BATTERY PRECAUTIONS

- Only SHP approved batteries/battery packs can be used for any the Electronic Lockset.
- Do not attempt to repair, disassemble or modify the battery. Do not place or use battery near fires, heaters, direct sunlight, or other heat sources. Prolonged exposure to heat may cause battery leakage, explosions, or fires.
- Do not dispose of the battery as General waste. Please refer to local regulations.
- Do not place pressure on or pierce the battery with hard objects. Damaging the battery could cause battery leakage, overheating, or fires.

COMPLIANCE

The Electronic Lockset meets the CE and UKCA compliance requirements



FIRE PERFORMANCE

Our lockcase is rated up to FD60

For more information regarding certificated test evidence please contact SHP

t: +44 (0) 330 058 0988

e: info@safehingeprimera.com

SUPPORT

REPORTING A FAULT

Issues should be reported to your maintenance provider. If you need manufacturer's support please contact SHP: support@safehingeprimera.com or 0125 320 7096.

SPARES

Replacement battery packs are available from Safehinge Primera. Further spares are available on request, contact SHP for details and support: info@safehingeprimera.com or 0330 058 0988.

MANUFACTURER'S WARRANTY

Refer to SHP document SCT056 for details of Safehinge Primera Product Warranties. Contact SHP to obtain the warranty document: info@safehingeprimera.com or 0330 058 0988.

t 0330 058 0988

e info@safehingeprimera.com

w www.safehingeprimera.com

Blackpool Office

Unit 8 Bankfield House

250 Bristol Avenue

Blackpool

FY2 0JF

Glasgow Office

44 Speirs Wharf

Glasgow

G4 9TH